



Electronic Service Manuals

This electronic document is provided as a service to our customers. We do not create the contents of the information contained in this document. Should you have detailed questions pertaining to the information contained in this document, you may contact Michco, or the manufacturer which provided the original information in this electronic deliverable. Michco's only part in this electronic deliverable was the electronic assembly process.

You may contact Michco through the following methods:
Phone (517) 484-9312 or (800) 331-3339 MI, OH, IN only
2011 N. High St. -- Lansing, Michigan -- 48906
Fax: (517) 484-9836
Email: CustServ@Michco.com
Web site: www.Michco.Com
Parts Web site: www.FloorMachineParts.Com

Order Parts on Line at:
www.FloorMachineParts.Com

Directly to Parts & Service:
By Email: **Shop@Michco.com**
By Fax: (517) 702-2041
By Voice: Use numbers above.

Serving the Cleaning Industry Since 1922

Notice: All copyrighted material remains property of original owners, all trademarks are property of respective owners. Manuals are subject to Manufacturer's reproduction limitations. Originals or reproductions were provided by manufacturers through a request. We make no warranty as to the correctness of information provided in this document and you assume all risk.

**390
Vacuum
Series
15 & 20
Gallon Units
Polyethylene**

**Model: C39085-05,06
C39105-05,06
C39130-05,06
C39085-15,20
C39105-15,20
C39130-15,20**

■ OPERATION ■ SERVICE ■ PARTS ■ CARE

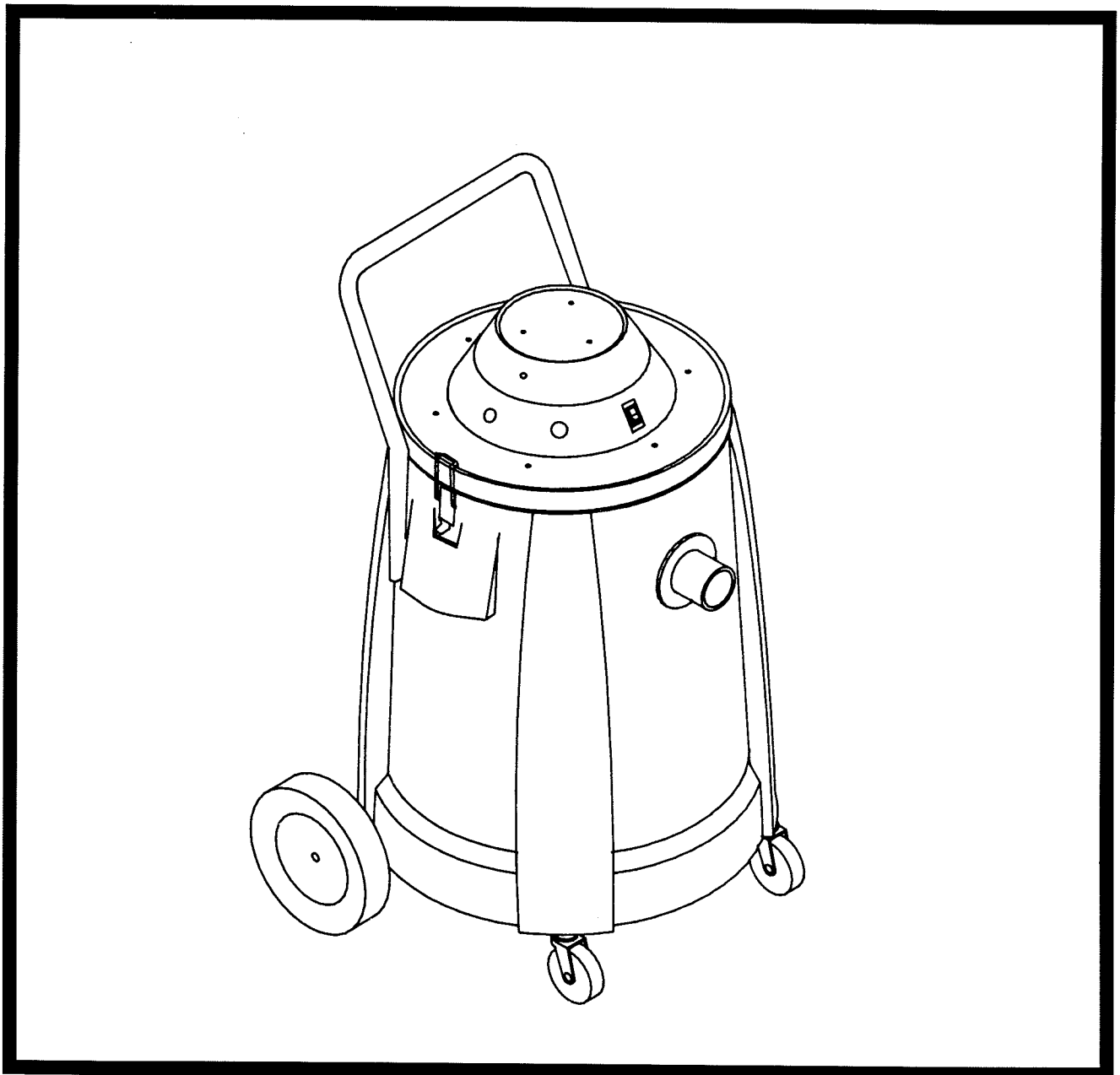

Revised 8/93

Minuteman[®]

FOR COMMERCIAL USE ONLY

IMPORTANT SAFETY INSTRUCTIONS

When using an electrical appliance, basic precautions should always be followed, including the following:

READ ALL INSTRUCTIONS BEFORE USING

WARNING - To reduce the risk of fire, electric shock, or injury:

- Do not leave appliance when plugged in. Unplug from outlet when not in use and before servicing.

WARNING

To reduce electric shock, do not expose to rain, store indoors.

- Do not allow to be used as a toy. Close attention is necessary when used by or near children.
- Use only as described in this manual. Use only manufacturer's recommended attachments.
- Do not use with damaged cord or plug. If appliance is not working as it should, has been dropped, damaged, left outdoors, or dropped into water, return it to a service center.
- Do not pull or carry by cord, use cord as a handle, close a door on cord, or pull cord around sharp edges or corners. Do not run appliance over cord. Keep cord away from heated surfaces.
- Do not unplug by pulling on cord. To unplug, grasp the plug, not the cord.
- Do not handle plug or appliance with wet hands.
- Do not put any object into openings. Do not use with any opening blocked; keep free of dust, lint, hair, and anything that may reduce air flow.
- Keep hair, loose clothing, fingers, and all parts of body away from openings and moving parts.
- Do not pick up anything that is burning or smoking, such as cigarettes, matches, or hot ashes.
- Do not use without dustbag and/or filters in place.
- Turn off all controls before unplugging.
- Use extra care when cleaning on stairs.
- Do not use to pick up flammable or combustible liquids such as gasoline or use in areas where they may be present.
- Connect to a properly grounded outlet only. See grounding instructions.

SAVE THESE INSTRUCTIONS

INSPECTION

Carefully unpack and inspect your machine for shipping damage. Each unit is tested and thoroughly inspected before shipment, and any damage is the responsibility of the delivery carrier who should be notified immediately.

ELECTRICAL - 115 Volt

This machine is designed to operate on a standard 15 amp, 115 volt, 60 hz, AC circuit. Voltages below 105 volts AC or above 125 volts AC could cause serious damage to the motor.

ELECTRICAL - 240 Volt

This machine is designed to operate on a standard 10 amp, 230 volt, 50 hz, AC circuit.

WARNING

Electric motors can cause explosions when operated near explosive materials or vapors. Do not operate this machine near flammable materials such as solvents, thinners, fuels, grain dust, etc.

GROUNDING INSTRUCTIONS

This appliance must be grounded. If it should malfunction or breakdown, grounding provides a path of least resistance for electric current to reduce the risk of electric shock. This appliance is equipped with a cord having an equipment-grounding conductor and grounding plug. The plug must be plugged into an appropriate outlet that is properly installed and grounded in accordance with all local codes and ordinances.

DANGER - Improper connection of the equipment-grounding conductor can result in a risk of electric shock. Check with a qualified electrician or service person if you are in doubt as to whether the outlet is properly grounded. Do not modify the plug provided with the appliance -- if it will not fit the outlet, have a proper outlet installed by a qualified electrician.

This appliance is for use on a nominal 120-volt circuit and has a grounding plug that looks like the plug illustrated in sketch A below. Make sure that the appliance is connected to an outlet having the same configuration as the plug. No adapter should be used with this appliance.

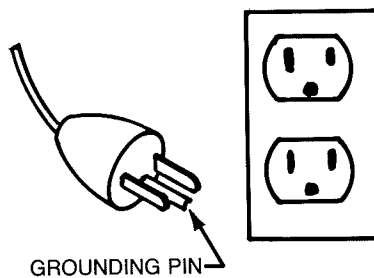

SKETCH A

USER MAINTENANCE INSTRUCTIONS

All service and repair should be performed by a qualified vacuum service representative or electrician. No user serviceable components are employed in the electrical vacuum lid head assembly. No lubrication of the motor is required.

CLOTH BAG & HOSE ASSY



Cloth bag and hose assy. are user maintenance items and can be replaced when worn out. Cloth bags can be maintained by blowing dust off of the bag and then laundered. Cloth bags should be completely dried before re-installing into machine. For optimum performance, empty and clean filter bag regularly. A clogged and dirty bag restricts the flow of air and results in reduced vacuum. The Hose Assy. can be maintained by wiping off with a dampened cloth of mild liquid soap and water, then allowed to dry.

CORD STORAGE

While not in use storage can be accomplished by winding cord around motor lid assy. Cord should be completely unwound from Lid Assy. during operation.

- Do not use with damaged cord or plug. If appliance is not working as it should, has been dropped, damaged, left outdoors, or dropped into water, return to service center.
- Do not pull or carry by cord, use cord as handle, close a door on cord, or pull cord around sharp edges or corners. Do not run appliance over cord. Keep cord away from heated surfaces.
- Do not unplug by pulling cord. To unplug, grasp the plug, not the cord.
- Do not handle plug or appliance with wet hands.
- Always unplug the machine when removing the head off the tank. This equipment should be stored indoors and not exposed to rain.

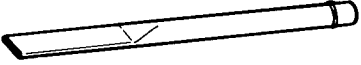
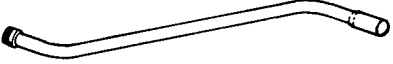
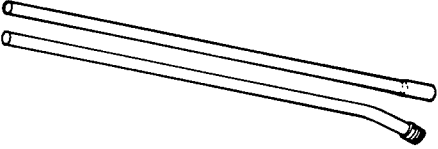
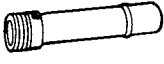
OPTIONAL INDUSTRIAL TOOLS AND ACCESSORIES

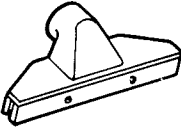
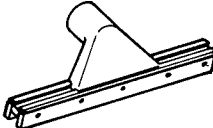
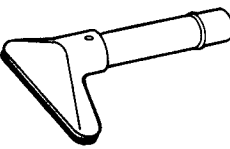
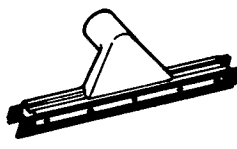
A		<p>800024 800022 800023 800175MCH 800176MCH 800025</p>	<p>3" Rd Dust Brush Complete 5" Rd Dust Brush Complete Bristle Insert 5" Dust Brush HSG 5" Dust Brush HSG 3" Bristle Insert 3"</p>
B		<p>800034</p>	<p>24" Crev Tool Aluminum, Complete</p>
C		<p>800015</p>	<p>Wand Asy 1-1/2, Complete</p>
D		<p>800017 800064 800019</p>	<p>Set Tube, High-up 10' 5' Tube Lower Section 5' Section Upper</p>
E		<p>800116</p>	<p>Swivel, Hose End Exp, Complete</p>
F		<p>801010</p>	<p>Hose Asy 1-1/2 x 10'</p>
G		<p>800032 711006 800033 800193POL</p>	<p>6" Curved Pipe Tool, Complete Set Screw Bristl Insert Curved 6" 6" Curved Pipe Tool</p>
H		<p>800072 710356 710357 800187PTD 800217 800218</p>	<p>12" Gulper Tool, Complete SCR-MC 10-32 x .62 SCR-MC 10-32 x .75 Gulper Nozzle Fibre Shoe Rear Fibre Shoe Front</p>
I		<p>800108 710530 800003MCH 800178PTD</p>	<p>14" Fibre Tool Complete Screw 8/32 x 1/2 Brass Fibre Shod Tool Casting</p>
J		<p>800038 800029</p>	<p>6" Tool W/Handle Tube, Complete Bristle Insert Replacement</p>
K		<p>800109 710330 800121 800178PTD 800239 800240</p>	<p>14" Squeege, Complete SCR-SC 8-32 x .62 14" Retaining Strip Casting, Tool MCH Blade Squeege Wide Blade Squeege Narrow</p>

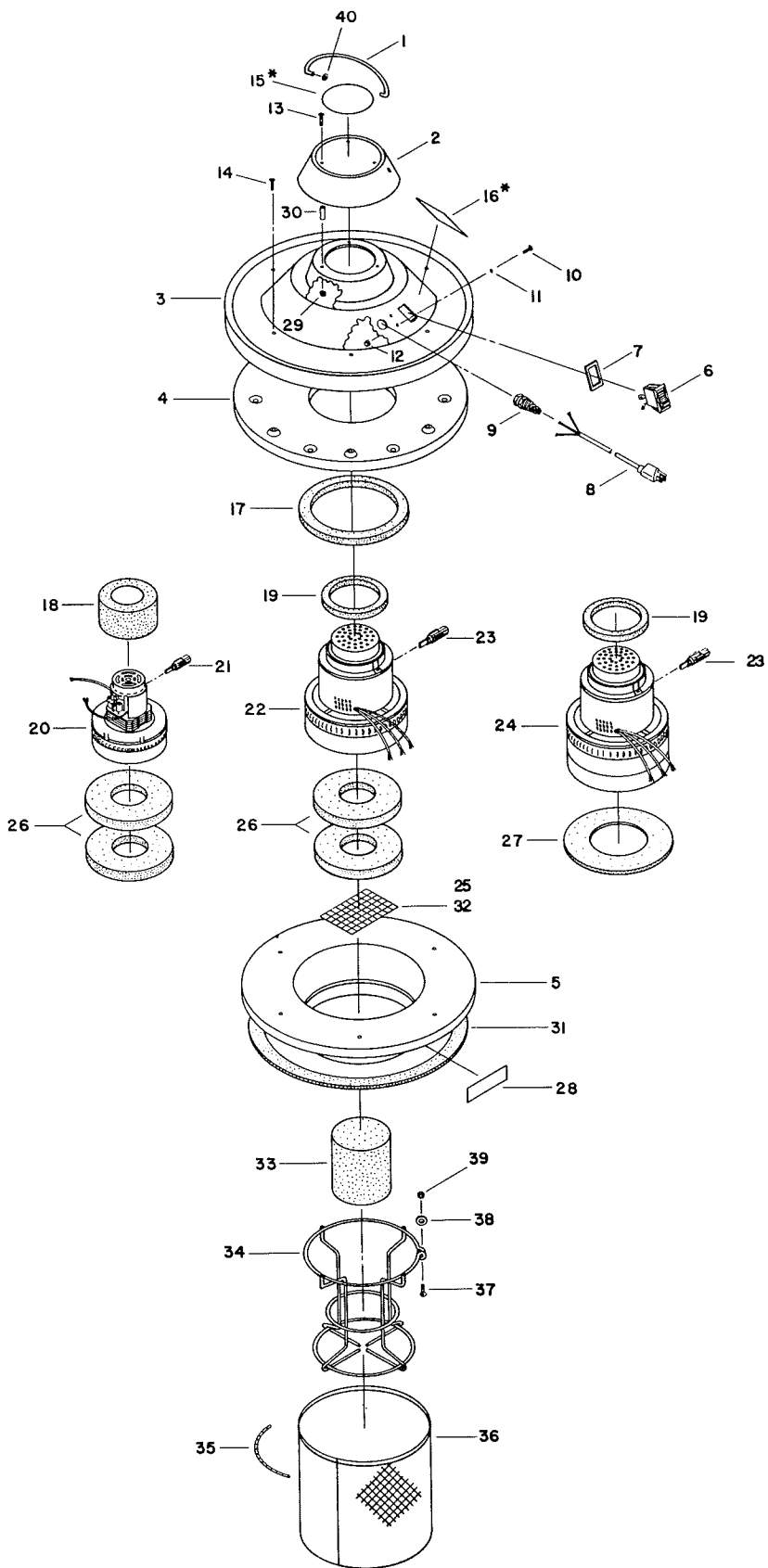

Vac Head Assembly

ITEM NO.	PART NO.	QTY.	DESCRIPTION
1	760899	1	Handle Bail
2	760898PLT	1	Cap, Motor
3	760897PLT	1	Cover, Motor
4	760896	1	Shroud, Motor
5	760895	1	Pan, Motor
6	809754	1	Switch Rocker
7	831543	1	Gasket, Diecut Switch
8	381020	1	Orange Cord Set 16-3 50'
8A	740600	1	Cord, International
9	833237	1	Strain Relief
10	710154	2	SCR-MC 10-32 x .562 SS
11	711553	2	WSR-Internal Lock #10
12	711310	2	Nut-Hex 10-32 STPL
13	712823	3	SCR-THMS 10-24 x 1.00 STPL
14	711129	6	SCR-ST-B 10 x 1.00 PL
15	715085	1	Decal, Diecut 85
	715105	1	Decal, Diecut 105
	715130	1	Decal, Diecut 130
16	715086	1	Decal, Diecut Warning
17	831478	1	Gasket, NEOP 6 x 7.5 x .37
18	380064	1	Ring, Foam
19	831484	1	Gasket, 3.5 x 4.5 x .31
20	380001	1	Vacuum Motor, Bypass 115V-85
20A	380054	1	Vacuum Motor, 240V
21	380028	2	Brush, Carbon 85
22	255039	1	Vacuum Motor, Bypass 115V-105
22A	255040	1	Vacuum Motor, 240V
23	255008	2	Brush, Carbon 105/130
24	831524	1	Vacuum Motor, 3-Stage 115V-130
25	832317	1	Screen, SS 130
26	828995	2	Gasket, NEOP 2.5 x 6 x .62
27	831626	1	Gasket 4 x 7.37 x .250
28	807932	1	Decal Screen 1 x 3
29	712908	3	Nut-Flanged Wizz 10-24
30	831652	3	Spacer
31	760225	1	Lid, Gasket .12 x .75 50" PS
32	807051	1	Screen SS 85/105
33	830986	1	Float
34	833454	1	Float Cage
35	760260	1	Spring, Bag Retainer
36	760901	1	Lint Filter
37	712569	1	SCR-MC 1/4-20 x 1.50 SS
38	711506	1	WSR-Flat 5/16 STPL
39	712667	1	Nut-Hex 1/4-20 SS Nyloc
40	711505	2	WSR-Flat 1/4
***40A	805073	2	Pin, Cotter

*** Not Shown

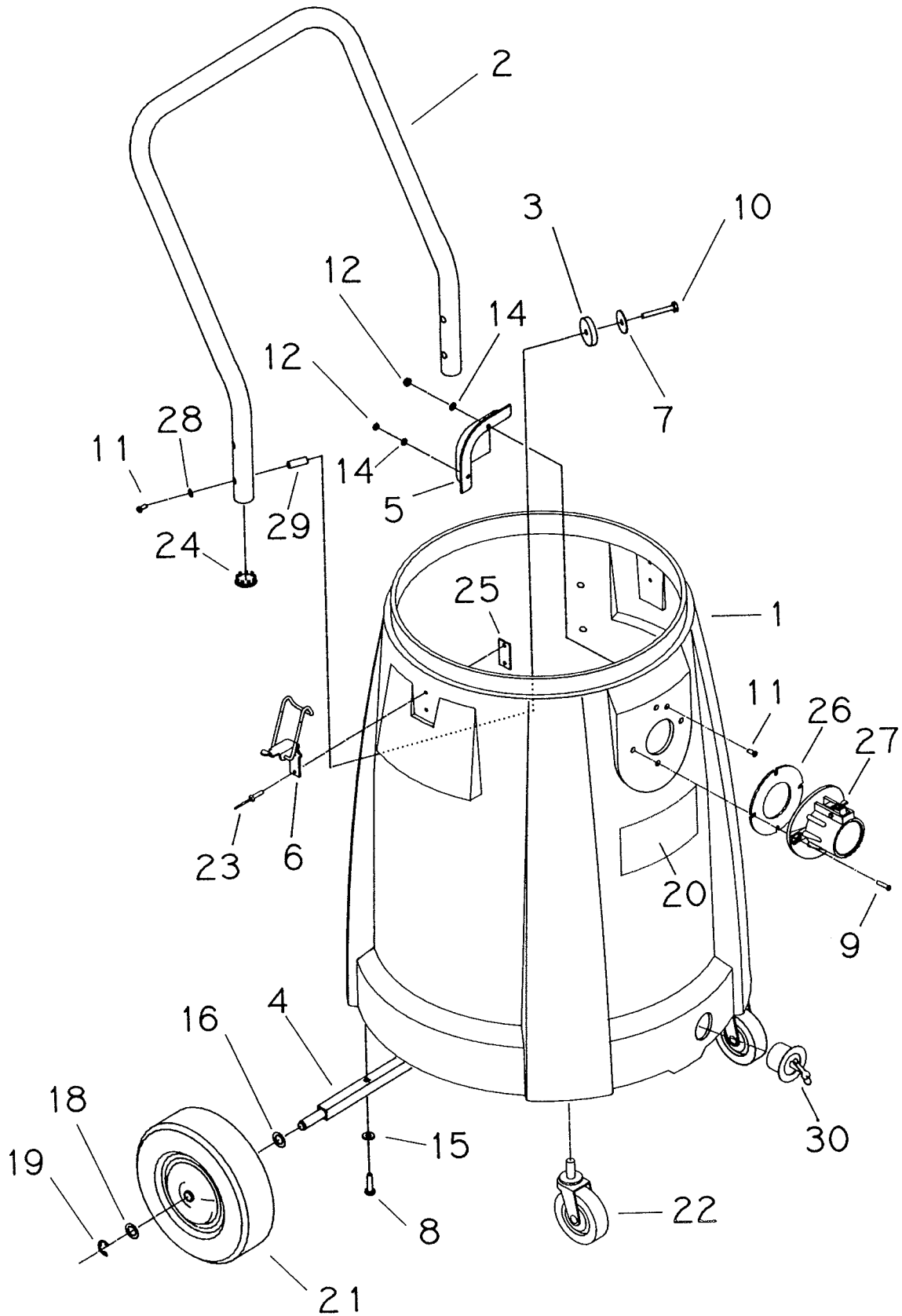

Parts List

ITEM NO.	PART NO.	QTY.	DESCRIPTION
1	390021MCH	1	Tank 15 Gal. Poly
1A	390025MCH	1	Tank 20 Gal. Poly
2	390031	1	Handle
3	828980	4	Gasket
4	390033	1	Axle
5	900035	1	Deflector, Intake
6	390035	2	Latch
7	712761	4	WSR-Flat
8	710182	2	SCR-MC 1/4-20 x 1.00
9	712532	2	SCR-MC 10-24 x 1.00
10	710387	4	SCR-MC 1/4-20 1.75
11	712819	1	SCR-MC 10-24 x .75
12	712638	3	Nut-Hex 10/24 SS Nyloc
13	711352	4	Nut-Acorn 1/4-20
14	712764	3	WSR-SS #10
15	711505	2	WSR-Flat 1/4
16	711524	2	WSR-Wave
18	711594	2	WSR-Flat
19	711713	2	Retaining Ring-E
20	715143	1	Decal
21	900040	2	Wheel
22	804457	2	Caster 3"
23	828893	4	Pop Rivet
24	832126	2	Tube Closure
25	833831	2	Clamp Back Plate
26	390087	1	Gasket, Diecut
27	390100	1	Intake Assembly Complete
28	711544	4	WSR-Helical 1/4
29	762399	4	Bushing

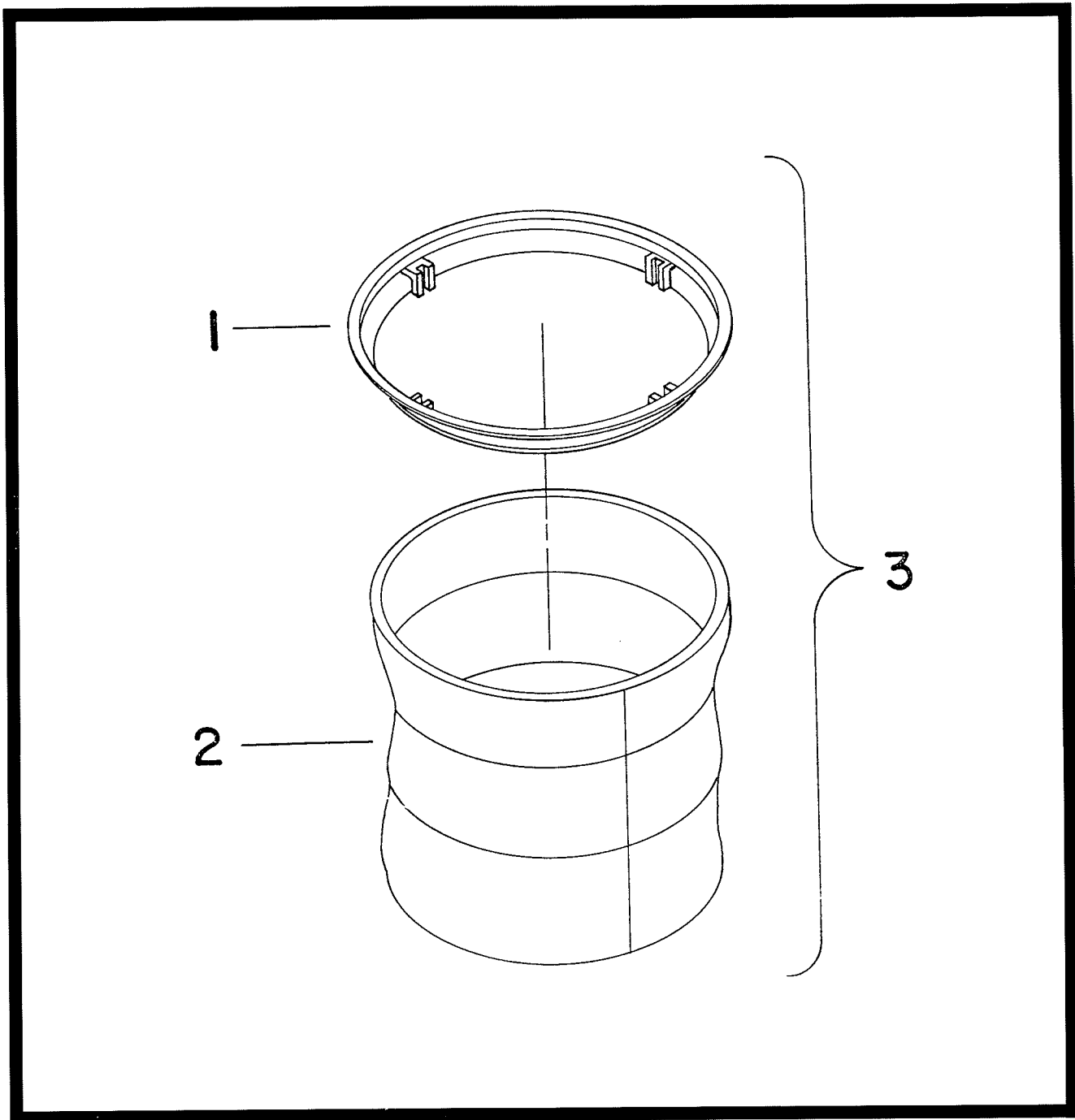

Parts Listing

ITEM NO	PART NO.	QTY	DESCRIPTION
1	760131	1	Molded bag ring
2	805054	1	Cloth bag only
3	805058	XX	Cloth bag asy. complete

HOSE ASSEMBLY COMPLETE

800309	2" X 10'	CRUSH PROOF
800310	2" X 15'	CRUSH PROOF
800311	2" X 25'	CRUSH PROOF
800312	2" X 10'	NEOPRENE
800313	2" X 15'	NEOPRENE
800314	2" X 25'	NEOPRENE

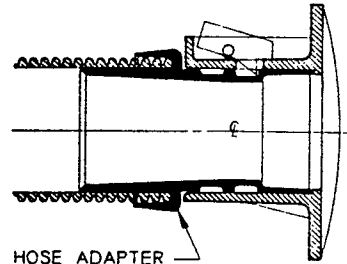

390020 - 2" HOSE ADAPTER

HOSE ASSEMBLY COMPLETE

800303	1-1/2" X 10'	CRUSH PROOF
800304	1-1/2" X 15'	CRUSH PROOF
800305	1-1/2" X 25'	CRUSH PROOF
800306	1-1/2" X 10'	NEOPRENE
800307	1-1/2" X 15'	NEOPRENE
800308	1-1/2" X 25'	NEOPRENE

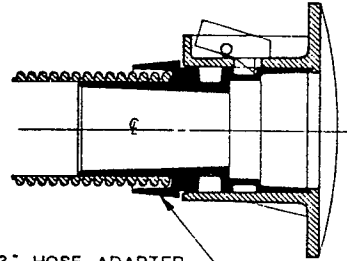

390015 - 1-1/2" HOSE ADAPTER

HOSE ASSEMBLY COMPLETE

800300	1-1/4" X 10'	CRUSH PROOF
--------	--------------	-------------

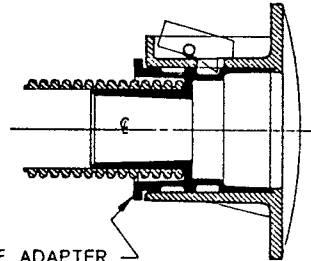

390012 - 1-1/4" HOSE ADAPTER

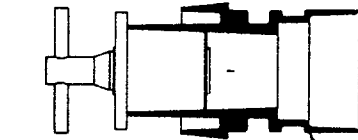

390038 ADAPTER PLUG ASSY FOR INJECTION MOLDED INTAKE (390100)

390100 INJECTION MOLDED INTAKE COMPLETE WITH PINS

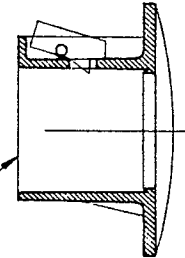

TANK SWIVEL CUFF ADAPTER

804003	1-1/4"
801014	1-1/2"

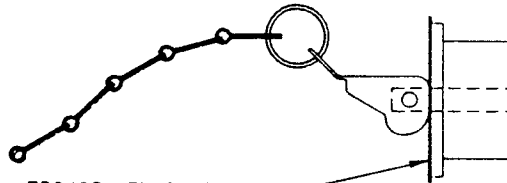
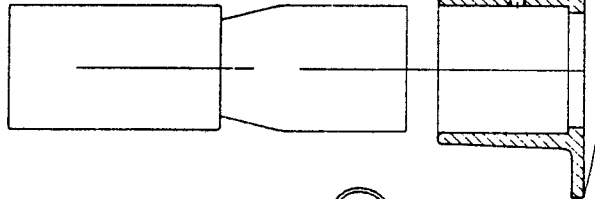

750402 PLUG ASSY FOR ALUMINUM INTAKE

LIMITED WARRANTY

Minuteman International, Inc. warrants to the original purchaser/user that this product is free from defects in workmanship and materials under normal use and service for a period of two years from date of purchase. In addition, Minuteman International, Inc. will, at its option, honor labor warranty claims for the first 12 months from date of sale, provided such claims are submitted through and approved by factory authorized repair stations. Minuteman International, Inc. will, at its option, repair or replace without charge, except for transportation costs, parts that fail under normal use and service when operated and maintained in accordance with the applicable operation and instruction manuals.

This warranty does not apply to normal wear, or to items whose life is dependent on their use and care, such as belts, cords, switches, hoses, rubber parts, electrical motor components or adjustments. Parts not manufactured by Minuteman International, Inc. such as engines, batteries, battery chargers, hydraulic pumps, and tires are covered by and subject to the warranties and/or guarantees of their manufacturers. Please contact Minuteman International, Inc. for procedures in warranty claims against these manufacturers.

Special warning to purchaser -- Use of replacement filters and/or prefilters not manufactured by Minuteman International, Inc. or its designated licensees, will void all warranties expressed or implied.

A potential health hazard exists without exact original equipment replacement.

All warranted items become the sole property of Minuteman International, Inc. or its original manufacturer, whichever the case may be.

Minuteman International, Inc. disclaims any implied warranty, including the warranty of merchantability and the warranty of fitness for a particular purpose. Minuteman International, Inc. assumes no responsibility for any special, incidental or consequential damages.

This limited warranty is applicable only in the U.S.A. and Canada, and is extended only to the original user/purchaser of this product. Customers outside the U.S.A. and Canada should contact their local distributor for export warranty policies. Minuteman International, Inc. is not responsible for costs or repairs performed by persons other than those specifically authorized by Minuteman International, Inc. This warranty does not apply to damage from transportation, alterations by unauthorized persons, misuse or abuse of the equipment, use of non-compatible chemicals, or damage to property, or loss of income due to malfunctions of the product.

If a difficulty develops with this machine, you should contact the dealer from whom it was purchased.

This warranty gives you specific legal rights, and you may have other rights which vary from state to state. Some states do not allow the exclusion or limitation of special, incidental or consequential damages, or limitations on how long an implied warranty lasts, so the above exclusions and limitations may not apply to you.

Minuteman[®]

World Headquarters

Minuteman International, Inc.
111 South Rohlwing Road
Addison, Illinois 60101

(630) 627-6900
FAX (630) 627-1130

Minuteman Canada, Inc.

2210 Drew Road
Mississauga, Ontario
L5S 1B1

(905) 673-3222
FAX (905) 673-5161